

10. Operation, maintenance and storage

- Always protect the pressure control panel against damage (check in regular intervals).
- Do not change the adjustment of the pressure regulators relief valve!
- Ensure perfect condition of seals, sealing surfaces and pressure gauges.
- In case of malfunctions - such as a rise in the outlet pressure while the flow rate is zero, leakage to the ambient air, defective pressure gauges or an opening of the relief valve - immediately shut down the system and close the gas cylinder valves.
- Before disconnecting the pressure regulator from the pressure control panel ensure that all pressure gauges show zero.
- General operating conditions, transport and storage
Transport and storage: -30°C up to 60°C
Atmospheric conditions (rel. humidity): 50 % at 40°C
90 % at 20°C
- Environment: Environment free from unusual amounts of dust, acids, caustic gases or substances like smoke, vapour, oil vapour, etc.
Note: The operation of pressure control panels in extreme weather conditions, especially at the coast, or on board of ships as well as vibrations or shocks impair the functional safety and are to be avoided.

Conditions differing from those described above may be agreed upon between manufacturer and user.

11. Notice for repair and service

- Repairs may only be carried out in authorized repair workshops by qualified staff.
- Only original spare parts must be used. The materials have been adapted to the gas type in each instance. So always specify the gas type.
- In case of independent repairs, the use of non-original spare parts or changes on the side of the user or a third party without the approval of the manufacturer, any form of liability for resulting damages will expire as well as the manufacturers warranty.
- After being repaired, the pressure regulator must be checked with respect to proper function, leak-tightness and cleanliness of the gas-wetted surfaces. When the system is used again, a sufficient purging operation must be carried out first.

Instruction for use Automatic change over panel BU 13-2U

spectrotec

Contents

	page
1. Application	
1.1 Designated use	1
1.2 Non-designated use	1
1.3 Technical data	2
1.4 Labeling	2
2. Safety instructions	3
3. Dimensions	4
4. General function	4
5. Functioning of changeover syst.	5
6. Installation	6
7. Initial start-up	
8. Cylinder exchange	7
9. Shut-down	7
10. Operation, maintenance and storage	8
11. Notice for repair and service	8

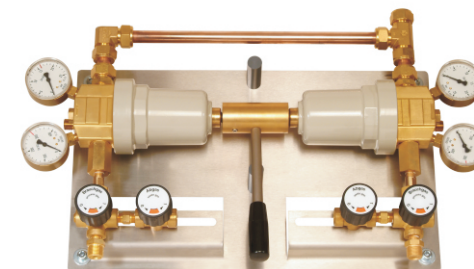

BU13-2U

1. Application

1.1 Designated use



Use this product for compressed gases or liquefied gases to reduce an inlet pressure to an as constant as possible outlet pressure.



It can be used in explosion endangered areas as it does not have an own potential source of ignition (ignition risk assessment according to DIN-EN 13463-1).

1.2 Non-designated use



Do not use the Product for gases in the liquid phase.



Do not apply unsuitable gas types or corrosive gases to this product.



Do not use it at temperatures below -30°C or above +60°C!

This product must only be used according to the instructions for use and under special consideration of the safety instructions!

1.3 Technical data

Model series	BU13- 2U
Inlet pressure P₁	max. 300 bar
Outlet pressure P₂	15 and 20 bar (depending on type)
Materials:	
Body / Springhouse:	Brass / Aluminium
Diaphragm:	EPDM
Valve stem:	PA 11
Mounting plate:	Stainless steel
Weight:	~ 17kg
Connection of panel:	Inlet: ½" BSP Outlet: Clamping ring fitting (18 mm)
Connection of extension:	Inlet: ½" BSP Outlet: ¼" NPT

Outlet pressure P ₂ [bar]	Flow rate (one-sided) in [m ³ /h] N ₂ at inlet pressure P ₁ [bar]				
	20	40	80	120	200
5	86	150	205	237	261
10	80	159	228	260	289
15	61	156	251	280	300
20	--	134	210	250	300

This control panel complies with the latest standards DIN-EN-ISO 7291
For special configurations these standards are observed accordingly.

Oxygen	0,93
Hydrogen	3,71
Argon	0,83
Carbon dioxide	0,79

For other gases this flow rate needs to be multiplied with the following factors:

1.4 Labelling

The front side of the mounting plate shows two labels. One label indicates the gas type for this panel and the other one (shown below) is the type label. It contains the following data:

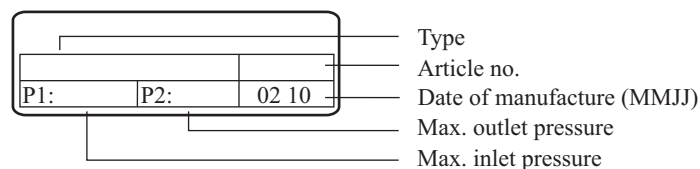

Test label

All pressure control panels are subject to a functional and leak test. After the test procedure a test label is attached to the backside of the mounting plate of each pressure control panel.

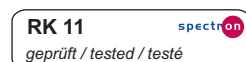

7. Initial start-up

Before starting up the operation please ensure that the automatic changeover panel is purged in order to clean the gas wetted areas from moisture and non process gases. Different methods (pressure buildup or continuous purging with process gas) can be applied depending on the downstream installations (shut-of valves, waste gas valves) and the cleanliness requirements. Always make sure that all gas wetted areas are affected by the purging process and that the purge gas is disposed safely.

- Preselect the gas withdrawal side by moving the lever up or down.
- ▲ Open the cylinder valves slowly.
- ▲ Open the process gas valves slowly. Take care to avoid any audible vibration of the regulators when filling the line downstream.
- Check the complete automatic changeover panel and all detachable connection for leaks.

8. Cylinder exchange

This chapter explains the cylinder exchange on the left [right] side and the subsequent purging process:

- Before changing the cylinder push the lever (13) down [up], otherwise changeover to the reserve cylinder on right side[left side] will not take place!
- Close the left [right] cylinder valve and the process gas valves (4 and 7).
- ▲ If a flammable or toxic gas has been withdrawn, purging must be carried out with an inert gas before changing the cylinder !
- Open the left [right] waste gas valve and close again (pressure relief).
- Close all process gas valves (4 and 7) on left [right] side.
- Disconnect the union nut on the cylinder valve.
- Secure a new cylinder to the cylinder bracket and connect the cylinder connection with a new or undamaged sealing washer (not necessary for metal to metal connections) to the cylinder valve.
- Open the process gas valves (7) (only existent if panel is equipped with extensions)
- Purge the gas wetted area upstream the process gas valve (4) to eliminate non process fluids:
 - Make sure that the process gas valve (4) is still closed
 - Open slowly the cylinder valve and close again.
 - Open the waste gas valve and close again before total depressurisation in order to avoid the reentry of air and moisture in the system.
 - Repeat this process approx. 10 times.
- Open the cylinder valve and the process gas valve (4)

9. Shut-down

- Close all cylinder valves. Close all process gas valves (4,7).
- Close low pressure shut-off valve (if installed).
- Open the waste gas valves (5) and close again (depressurise system).
- For starting up the pressure control panel again refer to chapter 7.

6. Installation of the panel

- The installation and start-up must only be carried out by qualified staff who had suitable training especially regarding the safety instructions. This safety training has to be repeated in periodical time intervals.
- All parts of the pressure control panel have been subject to a functional and a leak test. All in- and outlets are covered. The required seals and labels are scope of the delivery. The components are shipped pre-assembled as far as possible.
- Secure mounting plate, extensions (where applicable) and cylinder brackets to the wall with suitable screws if not provided.
- Place the gas cylinders in front of the cylinder brackets and secure them with a safety chain or belt.
- Check the cylinder valve connections (threads and seals) and the high pressure hose connectors for damages (where required, clean briefly connectors by using oilfree compressed air).
In case any thread, seal or sealing surface of the connectors is damaged, **do not** connect and pressurise the system.
- A separate shut-off valve in the outlet line is obligatory, when the tapping point does not provide the possibility to shut-off the line. Furthermore such a valve is also recommended when the tapping point is far-off the panel.
The minimum distance between the pressure regulator and the shut-off valve has to be $20 \times D_n$ (internal diameter of pipe).
- Connect the process gas outlet to the downstream line (a line shut-off valve is not supplied with this product) of the pipe system.
- For toxic or flammable gases connect waste gas valve outlets and relief valve outlet to a waste gas line. Ensure that the waste gas is disposed safely.

Installation of extensions

- Make sure the system is de-pressurized!
- Unscrew the connector (8) and the plug (12) of the process gas valve (7). Apply 5-10 clock-wise windings of PTFE-tape (Teflon-tape, article no. 0321422) to the thread of the plug (12) and keep the first thread free from teflon-tape and fix the end of the tape tightly. Then assemble the plug (12) at the former position of the inlet connector (8) and tighten it gas-tight.
- Screw in (at former position of the plug) the also PTFE-tape fitted clamping ring fitting of the connection kit (part-no. 71709238)
- Fix the extension (14) with pre-assembled connection kit (15) with suitable screws to the wall and hand-tighten the nut to the clamping ring fitting of the process gas valve (7).
For the initial installation tighten the nut another $1\frac{1}{4}$ turns. For all re-installations tighten the nut precisely to the point it was originally screwed. Find this point by marking it before disassembly!!
- Secure cylinder brackets with suitable screws to the wall.
- Position the cylinders in front of the cylinder brackets and secure them with a safety chain or belt.
- Check the cylinder valve connections (threads and seals) and the high pressure hose connectors for damages (where required, clean briefly connectors by using oilfree compressed air).
In case any thread, seal or sealing surface of the connectors is damaged, **do not** connect and pressurise the system.

2. Safety instructions

- All items of information marked with  are valid as special safety instructions.
 - This pressure control panel adheres to state-of-the-art technology and to the demands of the existing standards and regulations.
 - Changes or modifications are not allowed to be made to the pressure control panel without the prior consent of the manufacturer.
 - The result of improper handling and improper use as intended can involve risks for the user and other persons as well as damage to the device.
 - The equipment must be operated by suitable trained personnel only.
 - Regulations to be adhered to:
 - Accident prevention regulations
 - BGV A1 "General specifications"
 - BGV B6 "Gases"
 - BGV B7 "Oxygen"
 - BGV D1 "Cutting, welding and related processes"
 - BGV D4 "Electrical installations and working stocks"
 - BGV D34 "Liquefied gas"
 - Laws, prescriptions, technical regulations
 - Laws relating to technical working substances, (apparatus safety act, FTA) with general management regulations, as well as indexes A and B of the GtA.
 - Prescription relating to pressure containers, pressure gas containers and filling equipment, pressure container prescription) and general management regulations as well as appendices to the pressure container prescription.
 - Technical regulations pressure gases TRG, particularly TRG 280
 - Technical regulations TRR pipelines, particularly TRR 100
 - Ordinance relating to electrical equipment in rooms where there is a danger of explosion (ElExV).
 - Electrical equipment which is set up in areas where there is a danger of explosion VDE 0170 / DIN 57165
 - Electrical operating material for areas where there is a danger of explosion VDE0170/DIN 57 165
 - High voltage protection equipment VDE 0185/DIN 57 185
 - Instructions for the inclusion of pipelines in safety measures of high voltage equipment with a nominal voltage of up to 1000 V, VDE 0190
 - Code of practice and guidelines
 - Guidelines for the avoidance of danger of explosion following electrostatic supercharging
 - **Pressure equipment device 97/23/EG**
 - Guidelines for laboratories ZH1/119
 - Code of practice when handling pressure gas cylinders (DVS 0212)
 - Safety data sheets relating to the current sort of gas
- Special attention has to be paid to the country specific laws, regulations and procedures concerning the use of this type of equipment.**
- Use only for gas types the pressure control panel is labelled for.
 - Do not use at temperatures below -30°C or above +60°C.
 - All valves have always to be opened slowly! in order to avoid pressure shocks
 - All parts coming into contact with oxygen must be kept in oil-free and grease-free condition.
 - **Fire or explosion hazard!**
 - Smoking or open fire (e.g. candles) in the vicinity of the gas supply system is strictly prohibited.
 - **Fire and explosion hazard!**



3. Dimensions

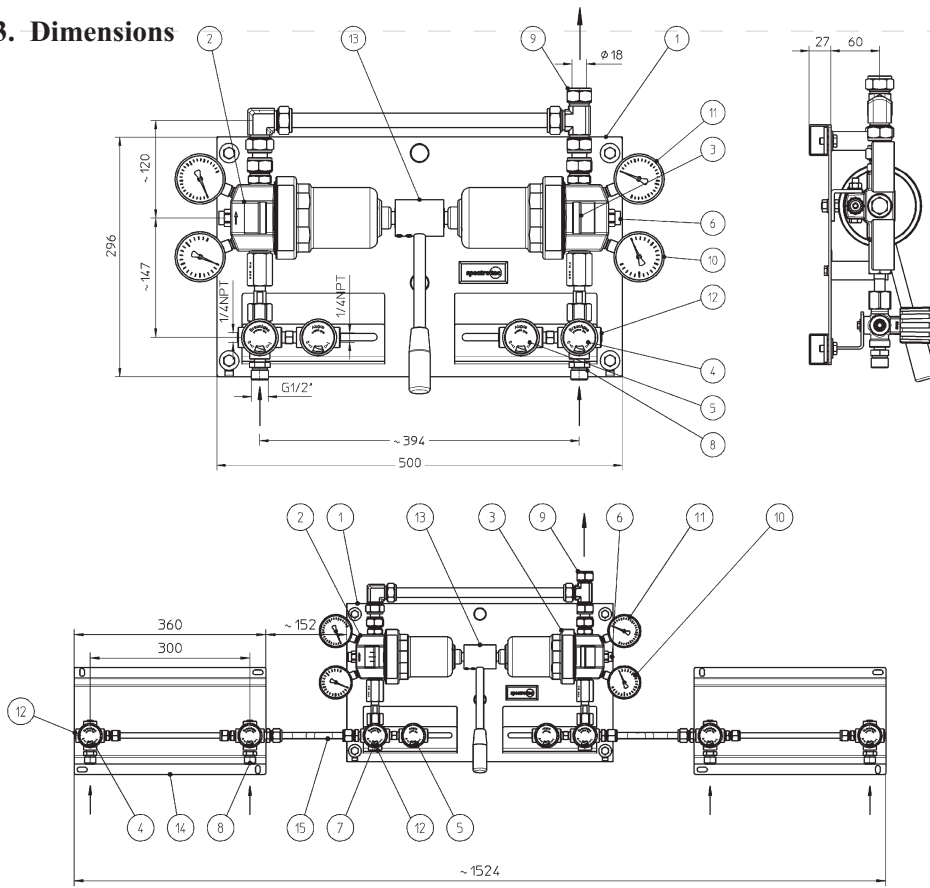

- | | |
|--------------------------------------|--------------------------|
| 1 Mounting plate | 8 Inlet connection |
| 2 Regulator left side | 9 Outlet connection |
| 3 Regulator right side | 10 High pressure gauge |
| 4 Process gas valve | 11 Outlet pressure gauge |
| 5 Waste gas valve | 12 Plug |
| 6 Relief valve | 13 Changeover system |
| 7 Central process gas shut-off valve | |

4. General functions

This automatic changeover panel consists of two pressure regulators which are connected on the outlet pressure side. Their outlet pressure setting is in the horizontal position of the changeover-lever equal. By pushing it down, the outlet pressure of the right regulator increases and the outlet pressure of the left decreases. In this position the process gas will only be taken from the right side because of the higher adjustment.

When the cylinder pressure of the right side drops below the outlet pressure set of the left side (changeover pressure), it will takeover automatically on the supply of process gas without interruption.

Before exchanging the cylinder, the position of the lever must be turned up in order to give delivery priority now to the left side by increasing its outlet pressure and so defining the right side as the reserve side.

5. Function of the changeover system

Both cylinders are full. Cylinder valves and process gas valves are opened. Lever turned up: The left side is selected for the gas withdrawal. The right side is in stand by.

The left cylinder becomes empty. Internal automatic changeover to the right cylinder takes place. Note: The outlet pressure will drop for about 3-4 bar.

Turn the lever downwards to increase the working pressure and hereby to select manually the right side for the gas withdrawal. Cylinders on the left side can be exchanged.

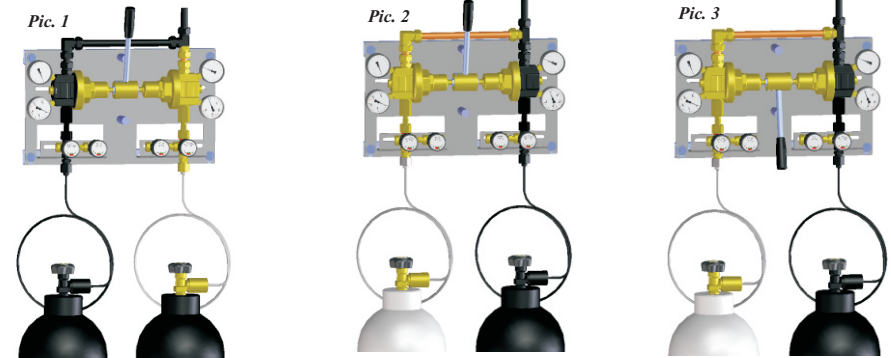

5.1 Change of outlet pressure setting

The automatic changeover is preset to a specific outlet pressure (see labelling). This setting can be varied within certain limits depending on the individual panel setup and regulator configuration. The limits have to be requested from the manufacturer.

- Bring the lever (20) in middle - horizontal - position.
- Unscrew the lever and the two head screws (21)
- Move the coupling element (23) to the left side until the countered nuts (22) of right side regulator are fully visible.
- Right regulator can now be readjusted to the new pressure setting by screwing the nuts
- Move the coupling element now to the right side and adjust the left regulator to the same pressure setting as the right regulator.
- Move the coupling element back in middle position and tighten both head screws.
- Reassemble the lever and select the side for gas withdrawal by pushing it up (left side is active) or down (right side is active)

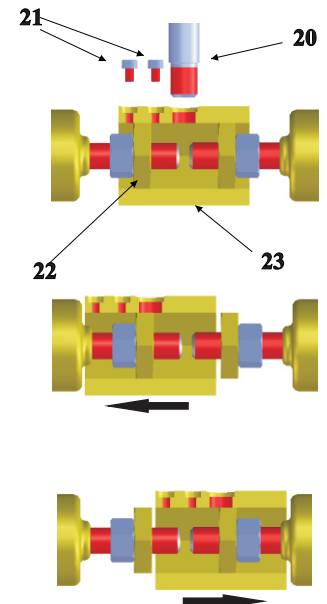

- 20 = Lever
- 21 = Head screw
- 22 = Countered nuts
- 23 = Coupling element