

spectroon



spectrocem



spectropur

Instruction manual
for
purge and connection block
SBE/3





Contents

Contents	2
1. Introduction.....	3
1.1 General.....	3
1.2 Description of the purge and connection blocks of series SBE/3	3
1.3 Intended use.....	4
1.4 Personnel requirements	5
2. For your safety	6
2.1 Symbols used.....	6
2.2 Essential safety information	6
3. Description	9
3.1 Overview of purge and connection block	9
3.2 Functional description	10
3.3 Technical data	11
3.4 Connection options.....	11
4. Operation.....	12
4.1 Labelling.....	12
4.2 Installation of the purge and connection block	12
4.3 Putting into operation and passivation	13
4.4 Gas cylinder change and passivation.....	16
4.5 Taking the equipment out of operation	17
5. Problems	18
6. Maintenance, cleaning and repairs.....	18
6.1 Regular maintenance work and visual inspections.....	18
6.2 Regular cleaning	19
6.3 Repair information.....	19
6.4 Returns.....	19

1. Introduction

1.1 General

Validity

This instruction manual is valid for purge and connection blocks of the SBE/3 series.

Manufacturer

Spectron Gas Control Systems GmbH
Fritz-Klatte-Straße 8
D-65933 Frankfurt
Deutschland / Germany
Phone: +49 69 38016-0
Fax: +49 69 38016-200
Email: info@spectron.de
Internet: www.spectron.de

Publication date

March 2017

Retention and completeness

- This operating manual forms part of the purge and connection blocks of series SBE/3, must be kept with the equipment at all times and made available to the relevant authorised persons.
- Under no circumstances may chapters be removed from this operating manual. If the operating manual is lost or if any pages are missing – in particular the "For your safety" chapter – it or they must be replaced without delay.

Copyright

This operating manual contains information that is protected by copyright. It must not be photocopied, reproduced, translated or copied onto data carriers, either in full or in part, without prior authorisation. All rights reserved.

Updates

No update service is provided for this operating manual by Spectron Gas Control Systems GmbH. Changes can be made to this operating manual without further notification.

1.2 Description of the purge and connection blocks of series SBE/3

Spectron purge and connection blocks in the SBE/3 series are used in gas supply systems for corrosive and/or toxic and/or high-purity gases.

Purge and connection blocks separate the gas supply behind the purge and connection block – which transports the process gas to the respective connected equipment – from the process gas source (e.g. gas cylinder with process gas) and the purge gas source (e.g. gas cylinder with purge gas).

1. Introduction

After shutting off the gas cylinder valve and the process gas outlet, the process gas can be removed from the entire cylinder connection section up to the gas cylinder valve by means of the integrated purge mechanism. If the purging process is carried out correctly (see description under Section 4.2), all corrosive and/or toxic and/or high-purity process gas is removed from the cylinder connection section and flushed into the waste gas line with the help of an inert purge gas (for example nitrogen). The gas cylinder can only be changed safely by the user when this has been done.

After connecting the new gas cylinder, the ambient gas which has penetrated the connection can be discharged into the waste gas line by repeated purging.

Purge and connection blocks are available in a model with NPT connection threads or with VCR fittings.

As an option, each shut-off and purge valve of the purge and connection block can be equipped with a pneumatic drive to allow supply and purging processes to be performed automatically via a control unit.

The Spectron control unit "Flopurge" can be used to activate the pneumatic drives.

1.3 Intended use

Intended use

Purge and connection blocks in the SBE/3 series are designed for use on gas cylinders with high-purity and/or corrosive and/or toxic gases or gas mixtures. The permissible gases and pressure ranges for the purge and connection blocks are specified on the type plate.

The purge connection allows purge and connection blocks in the SBE/3 series to be used with gases where the presence of atmospheric oxygen (in particular the moisture contained therein) is undesirable or hazardous or where the respective process gas must be removed before a gas cylinder change.

Purge and connection blocks without electrical components may be used in areas with potentially explosive atmospheres, as they comprise no potential source of ignition in themselves (ignition hazard assessment in accordance with DIN EN 13463-1).

Purge and connection blocks with electrical components must be evaluated with respect to the ignition hazard. The ignition hazard must be assessed on the basis of the documentation for the respective electrical components and the overall system. It is imperative to observe directives 2014/34/EU ("ATEX 114") and 1999/92/EC (ATEX 137) when assessing the ignition hazard.

Foreseeable misuse

The following operating conditions are deemed to constitute misuse:

- Operation with gases that are not specified on the type plate
- Use with fluorine or mixtures with a fluorine content of more than 10%
- Use with gases in their liquid state
- Operation outside of the permissible technical limit values
- Failure to heed and comply with any applicable company and legal regulations and other stipulations
- Failure to follow the instructions in this operating manual
- Failure to carry out inspection and maintenance work
- Failure to heed the information on the type plate and in the product data sheet

1. Introduction

1.4 Personnel requirements

Definition of an authorised person

An authorised person is a person with technical training who has received technical instruction on the system as a whole – gas cylinder – gas type – gas cylinder valve – pressure regulator – and the associated hazards and has successfully completed training in "The supply of pressurised gases" and "Handling corrosive and toxic gases and appropriate precautionary measures."

Tasks of the operating personnel

Operating personnel must identify problems or irregularities and – in as far as possible and permissible – remedy them.

Requirements for operating personnel

To be able to carry out the assigned tasks, operating personnel must meet the following requirements:

- The operating personnel must have received instruction in the operation of the purge and connection blocks from an authorised person and must have read and understood this operating manual in its entirety.

2. For your safety

2.1 Symbols used



Note! **Important!** **Warning!** **Danger!**



Danger indicates an imminent high-level risk which will result in fatal or severe injury if not averted. **This signal word is used for acute risks only.**



Warning indicates a potential hazard with medium risk which may result in fatal or serious injury if not averted.



Attention denotes a hazard with a low level of risk which may result in minor or moderate injury or damage to property if not averted.



Notes provide information facilitating operation of the equipment or warn of the risk of damage to property.

2.2 Essential safety information



Note!







The safety information given below is to be regarded as supplementary information to the relevant national accident prevention regulations and legislation. All relevant accident prevention regulations and laws must be observed under all circumstances.

Various laws, regulations, rules and directives must be complied with when handling pressurised gases. The following legislation and publications are applicable (although this is not necessarily a complete list):





- EU Directive 2009/104/EC (Work Equipment Directive)
- EU Directive 1999/92/EC (ATEX 137)
- EU Directive 98/24/EC (Dangerous Substances Directive)
- Industrial health and safety ordinance (implementation of Directives 2009/104/EC and 1999/92/EC in German law)
- Ordinance on hazardous substances (implementation of Directive 98/24/EC in German law)
- TRBS (technical regulations on industrial safety and health) publications
- German technical rules for hazardous substances (TRGS)
- TRAS (technical regulations on plant safety) publications
- BGV A1 German trade association basic accident prevention regulations
- BGR 104 German trade association rules on explosion protection
- BGR 132 German trade association rules for the avoidance of ignition hazards resulting from electrostatic charges
- BGR 500 2.26 German trade association rules on welding, cutting and related work procedures
- BGR 500 2.31 German trade association rules for working on gas lines
- BGR 500 2.32 German trade association rules for the operation of oxygen systems
- BGR 500 2.33 German trade association rules for the operation of systems that handle gas

2. For your safety

- BG RCI leaflet M034
- EIGA documents
- Safety data sheets for the gases used

	Possible hazard	Preventive measures
	If pure oxygen comes into contact with oil or grease, there is a risk of fire due to a chemical reaction.	Keep all parts that come into contact with pure oxygen free of oil and grease.
	Gas escaping into the ambient air can ignite; there is a risk of fire and explosion.	Smoking and naked flames are strictly prohibited near gas supply equipment.
	The purge and connection block may be damaged by unauthorised modifications or conversions and may no longer work as intended. There is a risk of the system malfunctioning, catching fire or getting damaged.	No modifications or conversions may be made without the written approval of the manufacturer's authorised technical personnel.
	Unforeseeable operating states may arise if the purge and connection block is used for gases and pressure ranges for which it is not designed.	The purge and connection block must be suitable for the relevant gas and the pressure ranges involved. Only use for the gases indicated on the device! If there are no gas types specified on the purge and connection block, consult the manufacturer to find out which gases it can be used with. On no account may the purge and connection block be put into operation without obtaining this information.
	Gas escaping in an uncontrolled manner in closed rooms can cause poisoning or displacement of the oxygen in the ambient air.	Make sure that the outlet ends of the blow-off pipes and waste gas lines of systems operated indoors are routed into the open air. In the case of toxic or corrosive gases or gases that are harmful to the environment in some other way, dispose of the blown-off gas in accordance with the applicable regulations.
	Oxygen that escapes in an uncontrolled manner indoors can result in a dangerous rise in the oxygen content of the air and an increase in the tendency of clothing and other objects to ignite.	Make sure that the outlet ends of the blow-off pipes and waste gas lines of oxygen systems operated indoors are routed into the open air, and do not start a fire or ignite a flame. Read the EIGA document SAG 79/04/E for more information.

2. For your safety

	Possible hazard	Preventive measures
	If the purge and connection block is used outside the specified ambient temperature range, there is a risk of the system malfunctioning, catching fire or being damaged.	Do not use in ambient temperatures below -30 °C or over $+60\text{ °C}$.
	The use of the pressure control panel with components or accessories that are not rated for the same pressure as the control panel itself can lead to serious damage or bursting.	Components or accessories (fittings, pipes etc.) connected to the pressure control panel must be rated for the pressure given on the type plate of the pressure control panel.
	If dirt particles penetrate the threads of the purge and connection block, there is a risk of malfunctions and damage.	When connecting up the purge and connection block, make sure there are no dirt particles on the threaded fittings. Clean the threads before connecting a new gas cylinder!
	If the device is not handled properly and used as intended, this may be dangerous for the user and others and may damage it.	Use and handle the purge and connection block only as described in this instruction manual.
	If the connecting surfaces or gaskets of the fittings are damaged or missing, there is a danger of gas escaping in an uncontrolled manner.	Check the connecting surfaces for damage, and do not install the purge and connection block if the connecting surfaces are damaged or gaskets are missing.

3. Description

3.1 Overview of purge and connection block

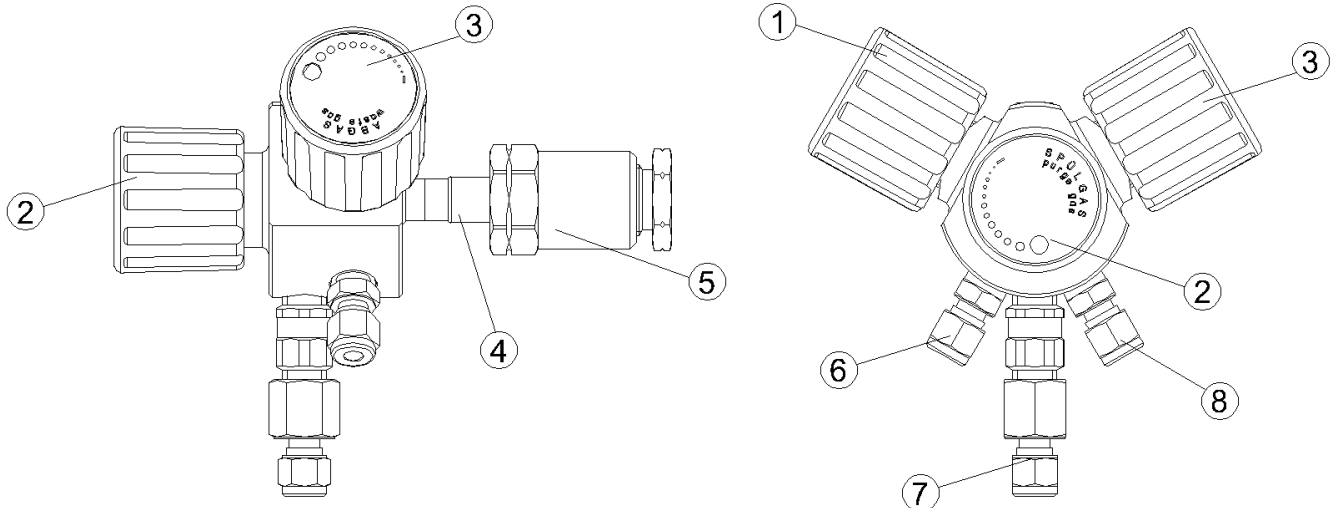

Elements of the purge and connection block

Item.	Designation	Function
1	Process gas valve	Used to separate the gas installation downstream of the purge and connection block from the gas cylinder.
2	Purge gas valve	Is opened to introduce purge gas.
3	Waste gas valve	Is opened to discharge waste process and purge gas.
4	Cylinder connection	The purge and connection block is connected to the gas cylinder at this point.
5	Locking cap	Used to close off the cylinder connection.
6	Connection, process gas pipe	The downstream gas supply system is connected to this outlet.
7	Connection, purge gas pipe	The purge gas supply is connected to this inlet.
8	Connection, waste gas line	The waste gas line is connected to this outlet.

Please take notice for purge and connection blocks with VCR-connectors:

The version SBE/3-MV3-R equals with respect to its configuration of elements to the picture and the table given above.

For the version SBE/3-MV3-L the valves on Pos.1 and Pos.3 are interchanged.

3. Description

Flow diagram of gas supply with purge and connection block

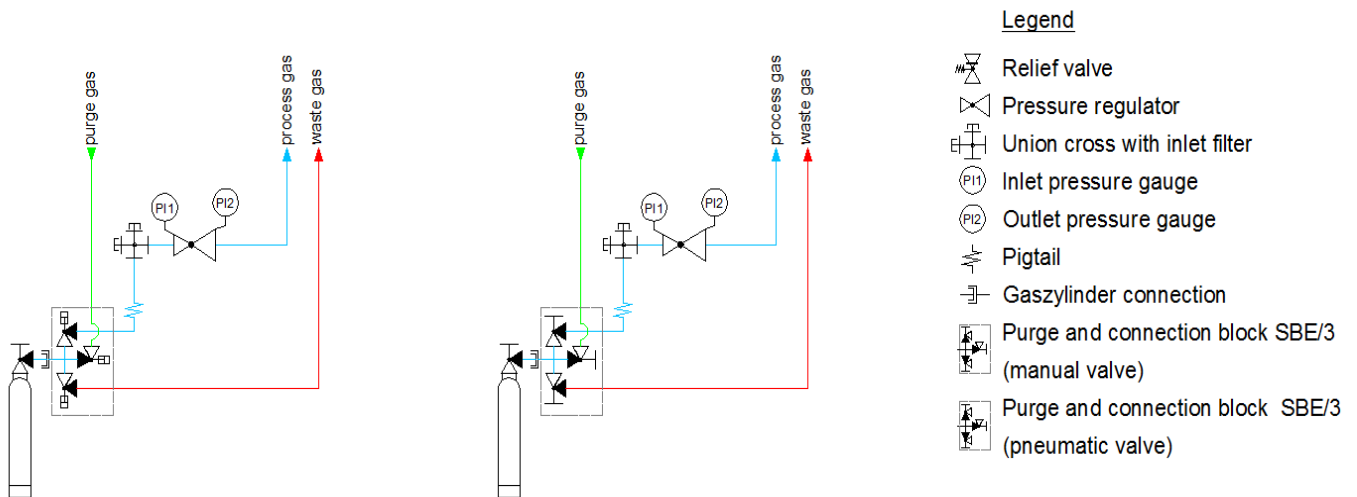

3.2 Functional description

Spectron purge and connection blocks in the SBE/3 series are used in gas supply systems for corrosive and/or toxic and/or high-purity gases.

Purge and connection blocks separate the gas supply system – which transports the process gas to the respective connected equipment – from the respective gas cylinder and the purge device integrated in the purge and connection block.

In addition, once shut off, the integrated purge mechanism allows the removal of the process gas from the entire cylinder connection section up to the gas cylinder valve.

If the purging process is carried out correctly (see description under Section 4.2), all corrosive and/or toxic and/or high-purity process gas is removed from the cylinder connection section and flushed into the waste gas line with the help of an inert purge gas (for example nitrogen). The gas cylinder can only be changed safely by the user when this has been done.

After connecting the new gas cylinder, the ambient gas which has penetrated the connection can be discharged into the waste gas line via the integrated purge device.

As an option, each shut-off and purge valve of the purge and connection block can be equipped with a pneumatic actuator to allow shut-off and purging processes to be performed automatically via a control unit. The pneumatic control pressure has to be within the range of 6 bar to 8 bar.

The Spectron control unit "Flo purge" can be used to activate the pneumatic actuators.

As an option, the purge and connection block can also be fitted with a contact pressure gauge. This gauge issues a switching signal when a specific pressure limit is violated or, in the same way as a pressure transducer, supplies a current that varies continuously with the pressure (4 – 20 mA).

3. Description

When these contact pressure gauges or pressure transducers are used in areas where there is a risk of fire or explosion, special measures have to be taken, as described in directive 2014/34/EU (ATEX 114) and 1999/92/EEC (ATEX 137).

The switching signal or variable electrical current can be processed by means of connected control units, resulting, for example, in the issue of a gas shortage alarm.



Important!

The control system should be configured so that an alarm or a shut-down is triggered when a pressure limit is violated. During manual operation, the pressure must be checked at regular intervals.

3.3 Technical data



Note!

The technical data can be taken from the Spectron data sheet for the relevant product. If this is not available, you can view and download it at www.spectron.de.

The nominal pressure of the fittings and the gas type are specified on the type plate.

3.4 Connection options

Designation	Model "Spectro cem"	Model "Spectropur"
Purge gas inlet	1/4" NPT female	VCR port with union nut
Waste gas outlet	1/4" NPT female	VCR port with union nut
Process gas outlet	1/4" NPT female	VCR port with union nut
Gas cylinder connection	Acc. to standard, depending on gas type	Acc. to standard, depending on gas type (with VCR gasket)

4. Operation

4.1 Labelling

Labelling example

Hydrogen (H₂)

SBE/3 – SE – DIN 1 – H2

P1: 200 bar



Note!

The purge and connection block must be labelled with the respective gas type! If the gas type is not specified on the type plate, contact the manufacturer for details.



Warning!

The purge and connection block must be used only for the gas type indicated by the labelling.

4.2 Installation of the purge and connection block



Important!

The connection threads and connecting surfaces of the gas cylinder valve and the purge and connection block and the gaskets must be checked to ensure that they are in perfect condition.

Step	Activity
1	Check that the purge and connection block is labelled as designed for use with the specific type of gas and that the nominal pressure of the fittings corresponds to the operating pressure of the system. Also check that all connection lines to the purge and connection block are clean, undamaged, correctly routed and labelled.
2	Connect the process gas pipe to the outlet labelled (6) as shown in the drawing in Section 3.1. Now connect the purge gas pipe to the inlet labelled (7) and the waste gas line to the outlet marked (8). Observe the installation instructions from the respective manufacturer when using compression screw fittings. A distinction must be made between completely new compression screw fittings and fittings which have already been pre-fitted to a pipe end. You can view or download the installation instructions for Spectron compression screw fittings at www.spectron.de . When fitting VCR connections, first tighten the pressure screw and union nut (with gasket inserted between them) by hand. Then, the connection must be tightened by one quarter turn using two wrenches. Tightening the connection further does not increase the leak-tightness. On the contrary, it can lead to damage to the VCR sealing lips.

4 Operation

3	If your purge and connection block has one or more pneumatic drives, connect the compressed-air line from the control unit (external diameter of the line: 4 mm) to the push-in elbow screw fitting provided and check that the line pressure is within the prescribed range.
4	If the pneumatic drive(s) is (are) equipped with sensor detection of the valve switching state (open/closed), connect the sensor cables from the control unit to the respectively designated sensors (process gas/purge gas/waste gas). Tighten the knurled nut on the sensor cable by hand.
5	Now connect the purge and connection block to the gas cylinder containing the process gas. To do this, remove the sealing plug (5) from the cylinder connection (4) of the purge and connection block and check once again that connection threads and gaskets are clean and in perfect condition.
	Tighten the threaded connection using a wrench.
6	Installation of the purge and connection block has been completed, and the purge and connection block can now be put into operation as described in the following sections.

4.3 Putting into operation and passivation



Important!

Prior to operation, check the labelling to ensure that the nominal pressure and gas type for which the purge and connection block is designed match the intended application. The purge and connection block must be used only for the gas type indicated by the labelling.



Warning!

All connection threads and connecting surfaces and the sealing rings must be checked to ensure that they are in perfect condition. Over-tightening screw connections can damage the sealing lips and may lead to leakage.



Danger!

If the fittings are used for gas mixtures with a fluorine content of up to 10%, the purging and passivation regulations must be strictly observed!

Fluorine mixtures are extremely toxic and corrosive gases. Violent reactions may occur if fluorine mixtures are applied to non-passivated surfaces or in combination with (air) humidity!

Do not use for gas mixtures with a fluorine content of more than 10 %!



Note!

Make sure that there is a purge gas pressure of at least 3 bar and that all waste gas lines are connected.

In general – but especially for filling the downstream installation the process gas valves must be opened gradually ensuring that any (audible) vibration of the pressure regulator is avoided.

Always turn the shut-off valves slowly and as far as the stop when opening or closing them!

4. Operation

Putting the equipment into operation, for all gas types except fluorine mixtures:

Step	Activity
1	<p>Purge and connection blocks in the SBE/3 series must be installed and connected to the gas cylinder in accordance with Section 4.2. All valves must remain closed. The position indicator of the handwheels shows whether the valves are still closed. A green dot is visible on the front end of the handwheel if the valve is open, a red dot if it is closed.</p> <p>If the purge and connection block is equipped with pneumatic drives, a green ring is visible beneath the screw connection for the actuating pressure if the valve is open. This ring is not visible in closed state.</p>
2	<p>First, purge the area of the gas cylinder valve and the purge and connection block (with the gas cylinder valve closed!). To do this, open the shut-off valve labelled "Purge gas." Wait until the full purge gas pressure has built up, and then close the shut-off valve again.</p>
3	<p>To relieve the pressure, open the shut-off valve labelled "Waste gas." Allow the purge gas to flow off and then close the shut-off valve immediately.</p> <p>Repeat steps 2 and 3 approx. five times!</p>
4	<p>Now purge the areas behind the purge and connection block by opening the shut-off valve labelled "Purge gas" again and allowing the pressure to build up. In addition, open the shut-off valve labelled "Process gas" and ensure that the purge gas can flow into all areas of the gas supply system to be purged. When the pressure has built up in all areas, close the shut-off valve labelled "Purge gas" again.</p>
5	<p>Check the leak-tightness of all connections while the full purge gas pressure is applied to the system.</p>
6	<p>Open a valve at the end of the gas supply system (near the connected equipment) and relieve the pressure by allowing the entire purge gas to flow into a waste gas line connected there and equipped with a downstream, safe disposal system. Close this shut-off valve again immediately.</p> <p>Repeat steps 4 and 6 approx. five times!</p> <p>Close all shut-off valves on the purge and connection block. The system has now been flushed with purge gas.</p>
7	<p>Open the gas cylinder valve on the cylinder for the actual process gas and then the process gas valve of the purge and connection block so that the entire area to be filled is filled with the process gas (pressure build-up).</p>
8	<p>Close the gas cylinder valve again, open the shut-off valve at the opposite end of the gas installation and relieve the pressure by allowing the entire process gas to flow off into a waste gas line connected there and equipped with a downstream, safe disposal system. Close this shut-off valve again immediately.</p>
9	<p>Open the gas cylinder valve to build up the pressure again, and repeat steps 7 and 8 approx. five more times.</p>
10	<p>The gas supply system is now filled with process gas, and tapping up to the actual process can now be performed.</p>

4. Operation



Important!

Before passivation, the entire gas-flow surface area must be flushed with purge gas!

Putting into operation and passivation for fluorine mixtures:

Step	Activity
1	Purge the gas supply system as described in Section 4.3, steps 4 to 6.
2	Open the gas cylinder valve and then the process gas valve of the purge and connection block so that the entire area to be filled is filled with the process gas (pressure build-up). To do this, set the pressure regulator to an outlet pressure of only 1 to 2 bar.
5	Close the gas cylinder valve.
6	Now set the pressure regulator outlet pressure to the maximum possible value.
7	Slowly open the downstream shut-off valves. Leave the fluorine mixture in the system as far as the connected equipment for approx. 30 minutes.
8	Open the waste gas valve and allow the fluorine mixture to flow off into a waste gas line equipped with a downstream, safe disposal system.
9	Repeat steps 2 to 8 once.
10	Now open the gas cylinder valve, set the pressure regulator to the required process pressure and start the tapping process.



Danger!

If parts of the system heat up during passivation, this indicates an ongoing chemical reaction. Immediately close all valves and relieve the pressure via the waste gas valve. Do not repeat the process until the cause of the heat reaction has been defined and remedied and the system has fully cooled down again.

4. Operation

4.4 Gas cylinder change and passivation



Important!

Check the gas cylinder connection for leak-tightness every time you change the gas cylinder. We urgently recommend that you replace the gasket every time the gas cylinder is changed! Always turn the shut-off valves slowly and as far as the stop when opening or closing them!



Note!

Make sure that there is always a purge gas pressure of at least 3 bar and that all waste gas lines are connected so that the purge gas can be discharged safely.

Changing the gas cylinder for all gas types (note the addendum to step 8 for fluorine mixtures)

Step	Activity
1	First, close the shut-off valve labelled "Process gas" on the purge and connection block.
2	Close the gas cylinder valve for the process gas.
3	Open the shut-off valve labelled "Waste gas" on the purge and connection block. Discharge the pressure and close the shut-off valve again.
4	Now open the shut-off valve labelled "Purge gas." Wait a moment to allow the full purge gas pressure to build up, and then close this shut-off valve again.
5	Open the shut-off valve labelled "Waste gas," relieve the pressure by allowing the entire purge gas to flow off and close the shut-off valve again immediately. Repeat steps 4 and 5 approx. ten times!
6	Release the gas cylinder connection and connect a new gas cylinder (pressure-tight!).
7	Now carry out steps 4 and 5 approx. five times.
8	Open the gas cylinder valve, wait for a moment until the pressure has built up and then close the gas cylinder valve again. In the case of fluorine mixtures: During the first two pressure build-up cycles (after closing the gas cylinder valve) leave the gas mixture under pressure for approx. 30 minutes.
9	Open the shut-off valve labelled "Waste gas" and relieve the pressure by allowing the process gas to flow off. Close this shut-off valve again immediately.
10	Carry out steps 8 and 9 approx. five times.
11	Open the gas cylinder valve and then the process gas valve and start the tapping process.

4. Operation

4.5 Taking the equipment out of operation



Note!

When taking the equipment out of operation for extended periods and before or after performing maintenance work on the gas supply system (requiring opening of the system to the atmosphere), the entire system must be purged as described in Section 4.3, steps 4 to 6.

Taking the equipment out of operation or interrupting operation for short periods (< 12 h)

When interrupting operation for brief periods, it is sufficient to close the shut-off valve on the connected equipment and close the process gas valve on the purge and connection block.

Taking the equipment out of operation or interrupting operation for extended periods (> 12 h)

Step	Activity
1	First, close the gas cylinder valve for the process gas.
2	Allow the process gas in the gas supply system to flow off (the process gas valve must be opened) by opening the valve labelled "Waste gas."
3	Now purge the gas supply system as described in Section 4.3, steps 4 to 6.
4	Close all valves and release the pressure on the pressure regulators.

5. Problems

Problem/cause	Remedy
There is a leak. This indicates a defective gasket or thread.	As the purge and connection block is often used within gas supply systems for corrosive and/or toxic gases, move away from the equipment immediately. Cordon off the area and observe all local regulations and emergency plans. When it is safe to enter the area again, close all valves. Check the gaskets and threads of all connections before putting the equipment back into operation. If necessary, have the purge and connection block inspected by the manufacturer or an authorised specialist company.
Valves cannot be opened and closed or can only be opened and closed with difficulty.	Have the purge and connection block inspected immediately by the manufacturer or an authorised specialist company.
Pneumatic drives do not react to control pulses.	Check the control unit. If necessary, have the purge and connection block inspected immediately by the manufacturer or an authorised specialist company.
Pneumatic drives react to incorrect control pulses.	Check the control unit. If necessary, have the purge and connection block inspected immediately by the manufacturer or an authorised specialist company.

6. Maintenance, cleaning and repairs

6.1 Regular maintenance work and visual inspections

Regular maintenance work

To ensure that the equipment remains in perfect working order and a constantly high level of operational safety and reliability is maintained, the purge and connection block should be inspected once per year by a specialist.

Regular visual inspections

Visual inspection of all parts for	Interval
<ul style="list-style-type: none"> • Damage • Function • Leaks • Integrity/stability • Corrosion 	Regular inspections at intervals of 12 months and each time the device is put into operation make an important contribution to the cost-effectiveness and preservation of the value of the fittings.



Note!

When used with corrosive gases, the durability and service life of the fittings depend to a large extent on the moisture content of the respective gases. Use dry gases and carry out purging as described to keep out moisture.

Do not put the purge and connection block into operation if defects are detected during a visual inspection! Have the fittings inspected immediately by the manufacturer or an authorised specialist company.

6 Maintenance, cleaning and repairs

6.2 Regular cleaning



Warning!

Detergents or disinfectants can corrode and ruin gaskets inside the fittings. Do not use detergents or disinfectants!

If the equipment gets very dirty, this can interfere with operation. If it becomes necessary to clean the purge and connection block, use only a damp, lint-free cloth.

6.3 Repair information



Important!

Repairs may only be carried out by specialist personnel in authorised repair workshops. After repairs, the purge and connection block must be checked in accordance with the original Spectron inspection instructions.

Safe and reliable operation can only be guaranteed if original spare parts are used.



Note!

The manufacturer accepts no liability for damage resulting from unauthorised repairs or modifications carried out by the user or third parties without the express written approval of the manufacturer.

6.4 Returns

If the purge and connection block is returned to the manufacturer for testing, maintenance or repair and it has been in contact with corrosive and toxic gases, it is imperative that it is purged with inert gas.

**Gebrauchsanweisung
Baureihe SBE**



Spectron Gas Control Systems GmbH
Fritz-Klatte-Straße 8
D-65933 Frankfurt
Deutschland / Germany
Phone: +49 69 38016-0
Fax: +49 69 38016-200
Email: info@spectron.de
Internet: www.spectron.de